



Die-cast



2206 Die-cast

50 watt - MR 16

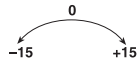
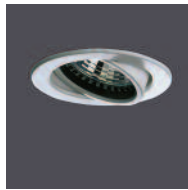

- GY 5,3 DICHOIC BULB
- MAX 50 W
- DIE-CAST ALUMINIUM BODY

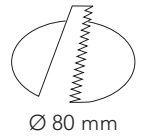
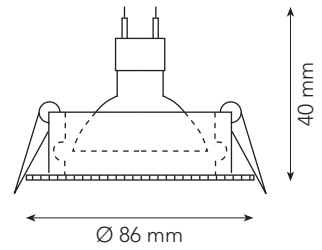

MATT WHITE



MATT BLACK



SATIN-ZAPON



CHROME

2240 Die-cast

50 watt - MR 16

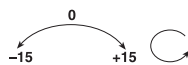

- GY 5,3 DICHOIC BULB
- MAX 50 W
- DIE-CAST ALUMINIUM BODY

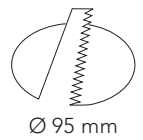
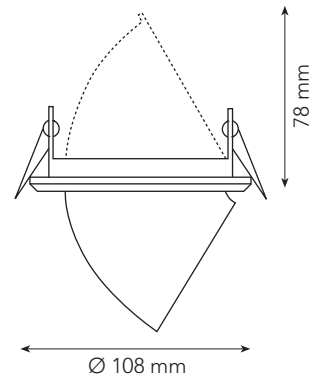

MATT WHITE



MATT BLACK



SATIN-ZAPON



CHROME

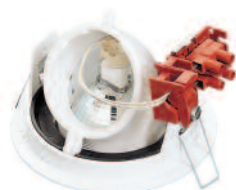

SECURITY BRACKET
(standard)



SCANDINAVIA SECURITY BRACKET
(on request)